

# JUAS 2025

## Vacuum simulations (MolFlow+) tutorial

Roberto Kersevan, Marton Ady, Petar Trifunović

12 & 14 February 2025

*Molflow version: 2.9.27*

### 1) Vacuum equations

Two fundamental equations of Ultra High Vacuum:

$$\begin{array}{c} \text{Gas input} \quad \text{Pumping speed} \\ \downarrow \quad \downarrow \\ \text{Pressure} \rightarrow p = Q/S \\ \text{Gas throughput} \rightarrow Q = C * dp \\ \uparrow \quad \uparrow \\ \text{Conductance} \quad \text{Pressure difference} \end{array}$$

Units (most used at CERN):

P (pressure): mbar (1 mbar = 100 Pa)

Q (gas flow): mbar\*l/s (1 mbar\*l/s = 0.1 Pa\*m<sup>3</sup>/s)

C (conductance): l/s

S (pumping speed): l/s

Conductance of a hole of area A:

$$C_{\text{hole}} = 1/4 * \langle v \rangle * A \quad \text{where } \langle v \rangle \text{ is the average molecule speed}$$

$$\langle v \rangle [\text{m/s}] = \sqrt{\frac{8RT}{\pi M}} \quad (\text{M: gas molar mass in kg, T: gas temperature in K})$$

Pumping speed of an area with sticking factor 's':

$$S = s * C_{\text{hole}} = s * 1/4 * A * \langle v \rangle$$

Local (effective) pumping speed at point B of a pump of speed  $S_A$  installed at point A:

$$1/S_{\text{eff,B}} = 1/S_A + 1/C_{A \rightarrow B} \quad \text{where } C_{A \rightarrow B} \text{ is the conductance between the two locations}$$

## 2) Molflow cheatsheet

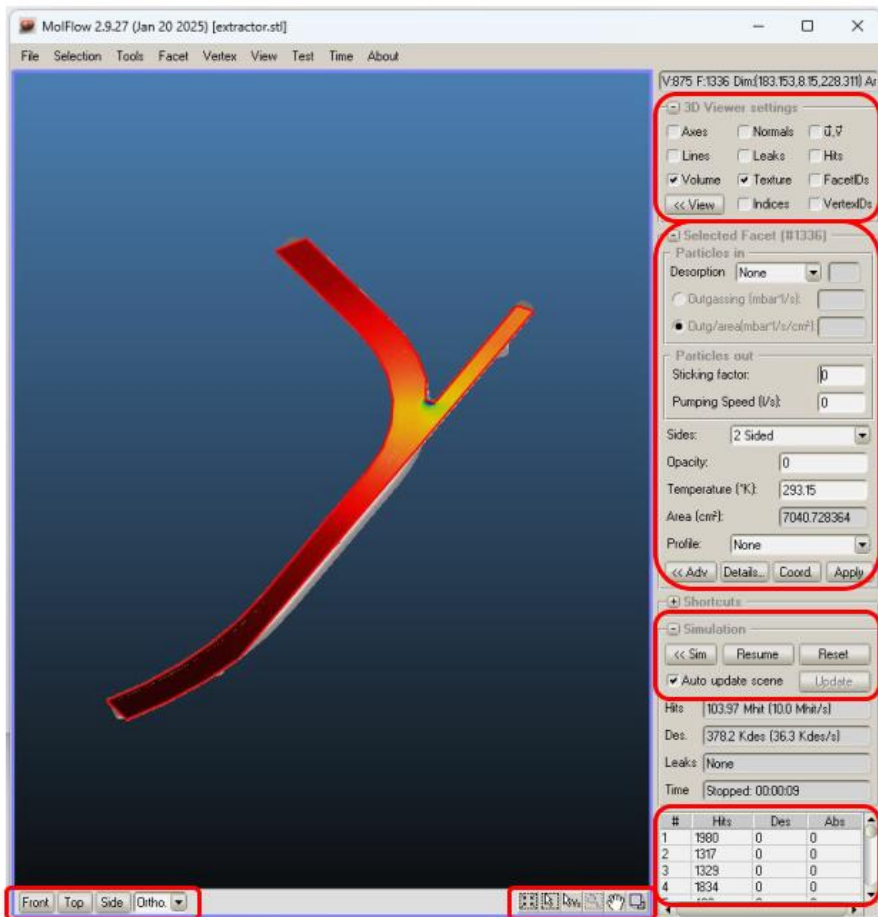

### View controls

Here you can toggle what's on the screen, i.e. enable/disable the display of textures, particle trajectories, etc

### Facet parameters

For the selected facets, you can set here:

- **Outgassing:** how many particles the facet is emitting
- **Sticking:** the pumping of the facet
- **Opacity:** how transparent the facet is
- **Profile and textures:** some of these are available in the expanding dialog when clicking on <<Adv

### Simulation control

Start, stop and reset the simulation here

### Facet list

You can select facets from here, and also check the number of Monte Carlo hits on each of them, which can serve as a diagnostic tool

### Camera tools

You can return to the default Front/Top/Side view here

### Selector tools

You can choose between vertex and facet selection, and also access the autoscale button

### Mouse controls:

**Selection:** left button

**Rectangle selection:** hold left button

**Add/Remove from selection:** hold SHIFT to add, CTRL to remove

**Rotation:** right button (slow rotation: hold SHIFT)

**Pan:** hold middle button (or D on keyboard)

**Zoom:** mouse wheel (slow / fast zoom: hold SHIFT / CTRL). Alternatively, hold Z on the keyboard and the left mouse button, and drag up/down

### 3) Guided work: Effective pumping speed calculation

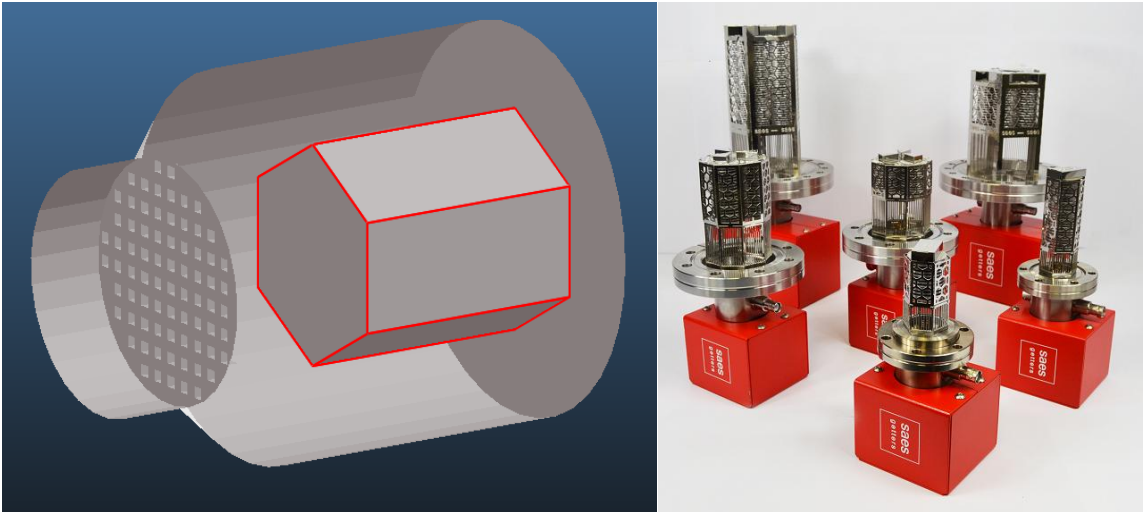

In this, first part we will approximate the effective (local) pumping speed of a NEG cartridge pump's pumping port. The goal is to use this result in the second part, when we'll be simulating a part of an accelerator.

#### Opening and collapsing the file

- Load **neg\_cartridge\_pump.stl**, a file originating from the CAD program, and choose **centimeters** as units. *Hint: STL files are also used by 3D printers, and as such, most CAD programs can export to it.*
- Since this file – at its opened form – contains only triangles, we need to **collapse** it: leave the default parameters as they are and click collapse:

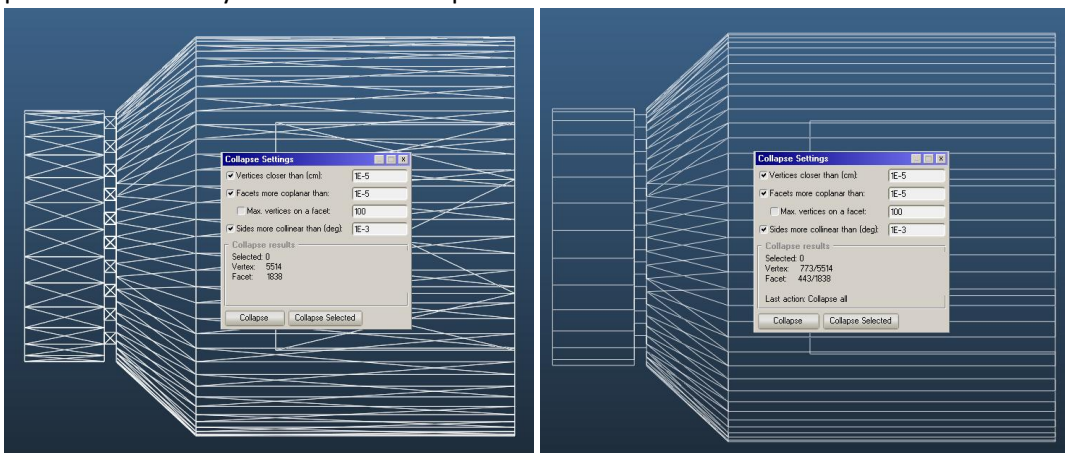

- You can now save the collapsed file in Molflow format, so during the tutorial you can save it with one click. Choose File/Save as, give the file a name, and press enter – Molflow will append the default .zip extension.

## Setting up desorption

- Select the pump entrance facet. On the right side, choose **Cosine** outgassing, then enter “1” (equals to 1 mbar.l/s) in the Outgassing field, and click Apply:

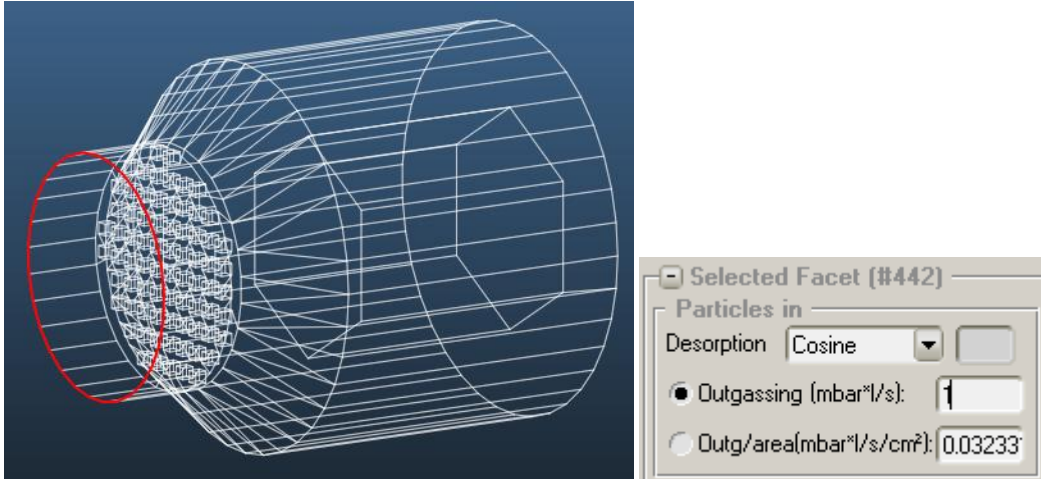

## Setting up pumping

- In this model, the pumping surfaces are those representing the NEG coating: they are the sides of the hexagonal volume.
- Select the six facets. *Hint:* you can select the hexagonal volume (7 facets) by a rectangle selection then deselect the end cap by a second rectangular selection holding CTRL
- Set sticking to 0.05, a conservative value for NEG. Don't forget to press ENTER or click Apply.

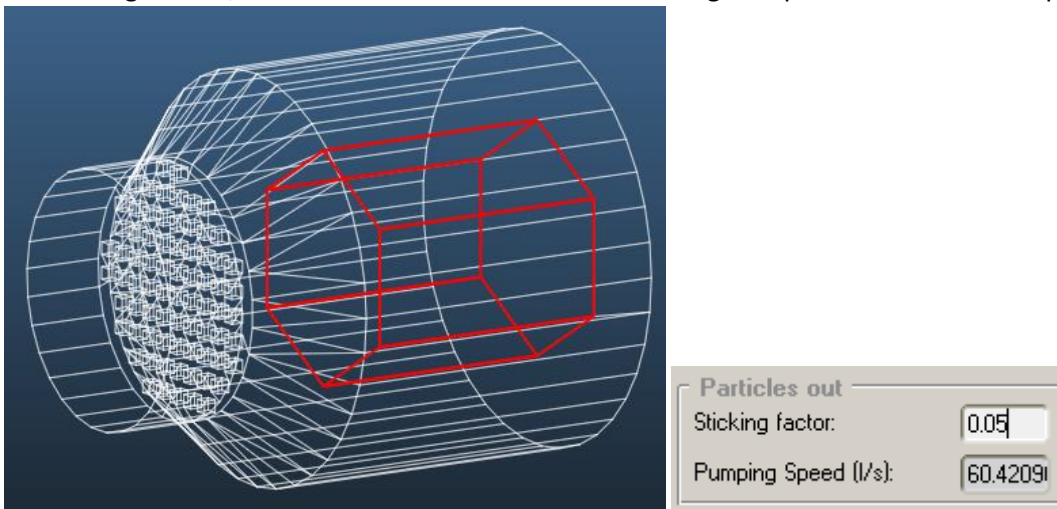

## Launching the simulation

- That's it! You have successfully set up outgassing and sticking, therefore all is ready to calculate.

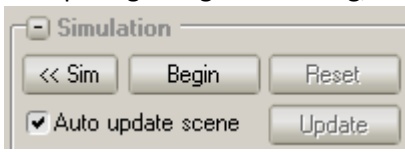
- Click the Begin button: 

- Turn on molecule trajectory display (**Lines** option, upper right) to check if everything is as intended:

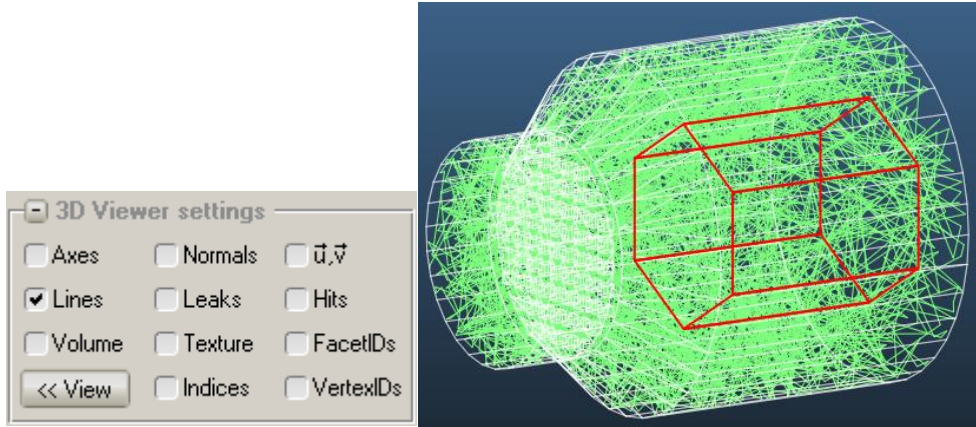

### Extracting results

The simulation can be stopped after a few seconds. It's a good time to save results.

We will see four different ways of getting the effective pumping speed:

- By reading the pressure on facets
- By using formulas
- By using profiles
- By using textures

### Reading pressure on facets

Select a facet near the entrance and one on the inside of the cartridge volume, the click Details. In the **Facet Details** window, you can read the pressures on the facets:

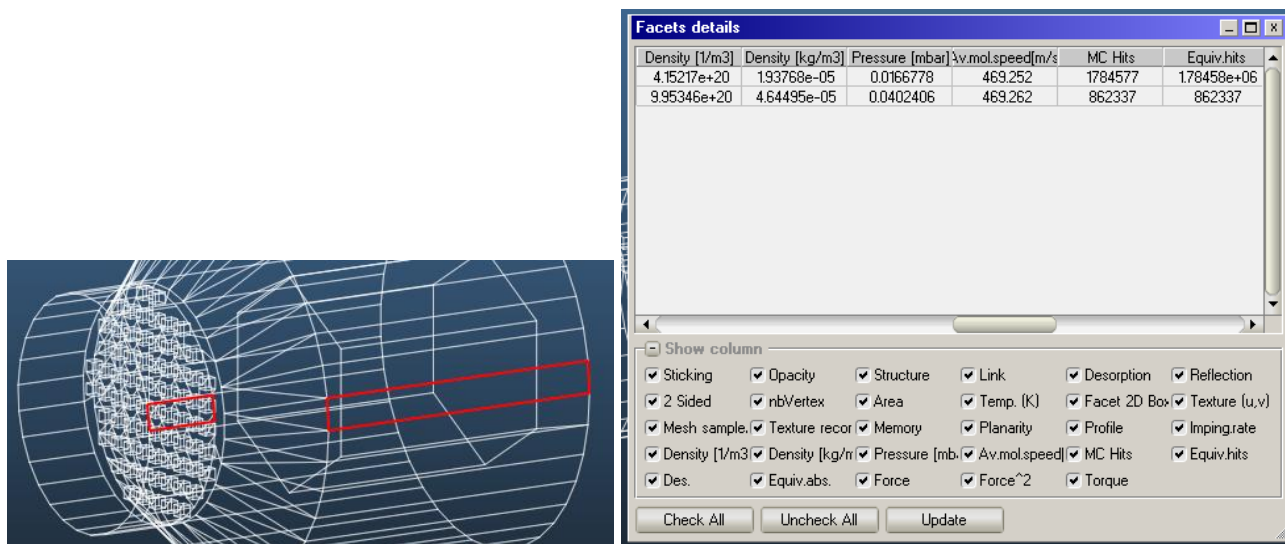

Staying at the values of the above screenshot, using the first equation of this note:

$$P_{\text{local}} = Q / S_{\text{eff}}$$

At the entrance:  $0.04 \text{ mbar} = 1 \text{ mbar.l/s} / S_{\text{eff}} \rightarrow S_{\text{eff}} = 1/0.04 = 25 \text{ l/s}$

At the pump volume:  $0.0166778 \text{ mbar} = 1 \text{ mbar.l/s} / S_{\text{eff}} \rightarrow S_{\text{eff}} = 1/0.0166778 = 60 \text{ l/s}$

Small note: you can verify that these values are correct. Select any of the NEG facets. You will see that the pumping speed (corresponding to our sticking factor of 0.05) is 10 l/s. As we have six of these facets, the local pumping speed is indeed 60 l/s.

## Using formulas

We can let Molflow evaluate the above equations for convenience. The calculated pumping speeds will be updated every second as the simulation is running, giving us an idea when the calculation has converged.

- In the Tools/Formula Editor menu option, we create new formulas, as in the screenshot:

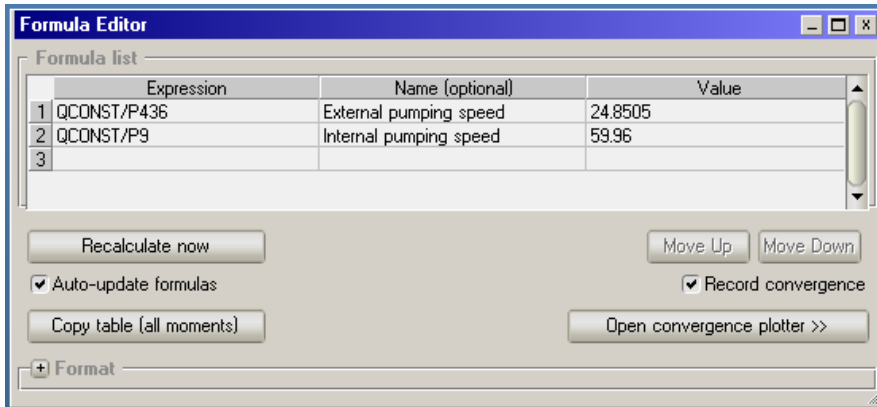

Explanation: QCONST is the outgassing, P436 is the pressure on facet #436 (in red)

- We add a second formula. Expression: QCONST/P9 (facet 9 is inside)
- Hint1:* you can access a cheat sheet of available formulas by expanding the Format panel

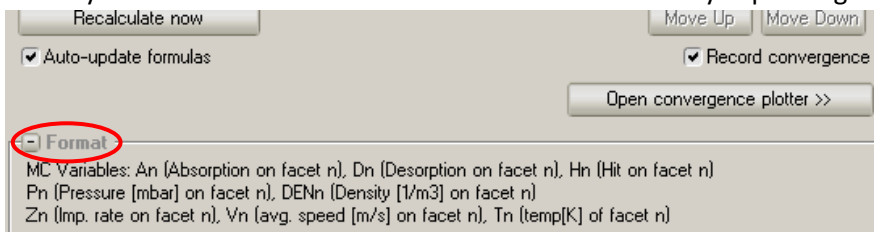

- Hint2:* if the values in the formulas don't appear or don't update, make sure to check the **Auto-update formulas** option as shown in the image above

## Using profiles

On **rectangular** facets, you can enable profiles which allow quick plotting of the pressure in a direction. Profiles can be set up on existing facets (on the walls), but for our purposes we will use a **transparent facet** that goes through the volume.

Although Molflow has geometry editing options, for simplicity we'll import an extra facet.

- Choose File / Insert geometry / To current structure and open **pump\_profile.zip**:

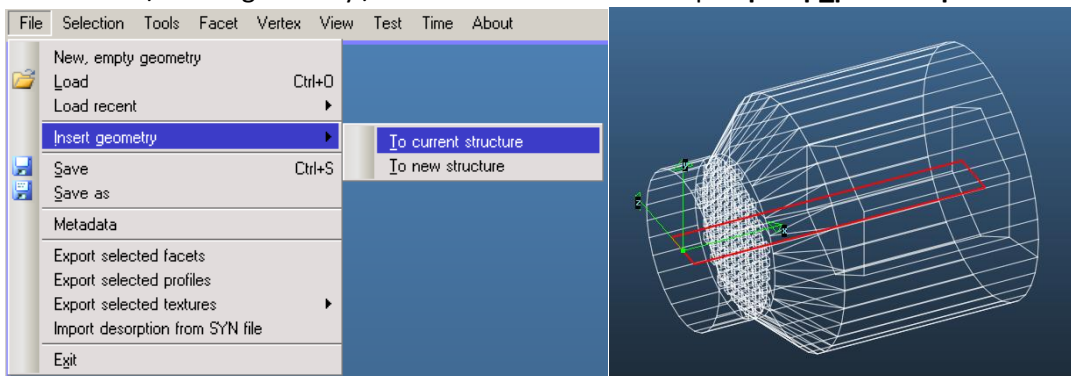

- Set the facet transparent (**opacity: 0**) and **2-sided**:

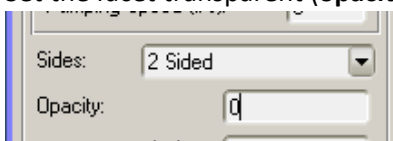

- Enable the **U,V vector** display (upper right), and check that the U vector is oriented along the facet's longer side:

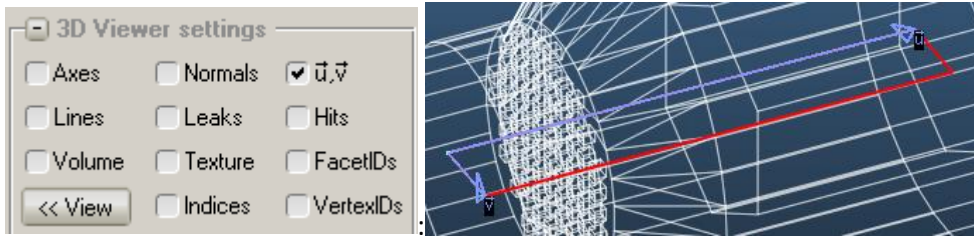

- Enable the **profile along the U vector**:

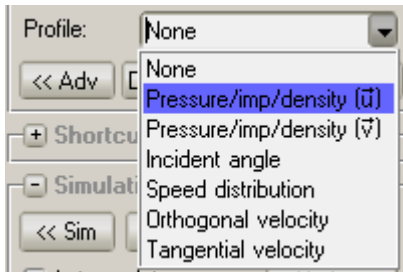

- Open the profile plotter, chooses the profile you just added and click **Add curve**, then run the simulation:

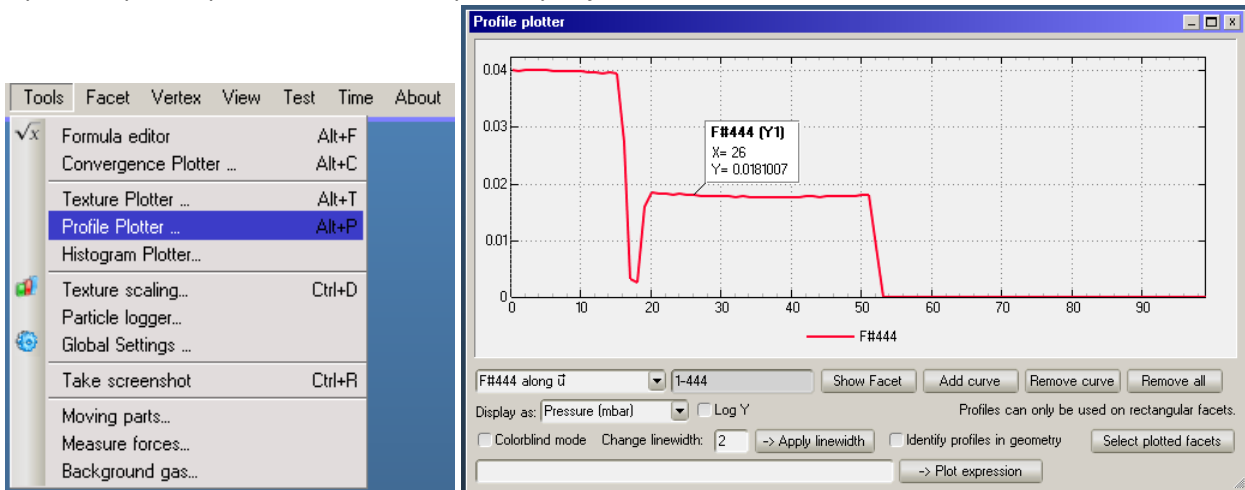

- When the simulation is stopped, clicking on the graph reveals the value. You can verify two things:
  - The pressure only drops at the grill (limited conductance)
  - Within volumes, it's almost constant (large conductance)
- Reading the pressure values (0.04 and 0.018 mbar) we can calculate the same pumping speeds

### Using textures

Textures are color-coded pressure values displayed directly on the facets.

For simplicity, we'll enable textures on all facets.

- Select all facets (by a rectangle or with the shortcut **CTRL+A**)

- On the facet parameters menu, open the advanced options by clicking on the << Adv button:

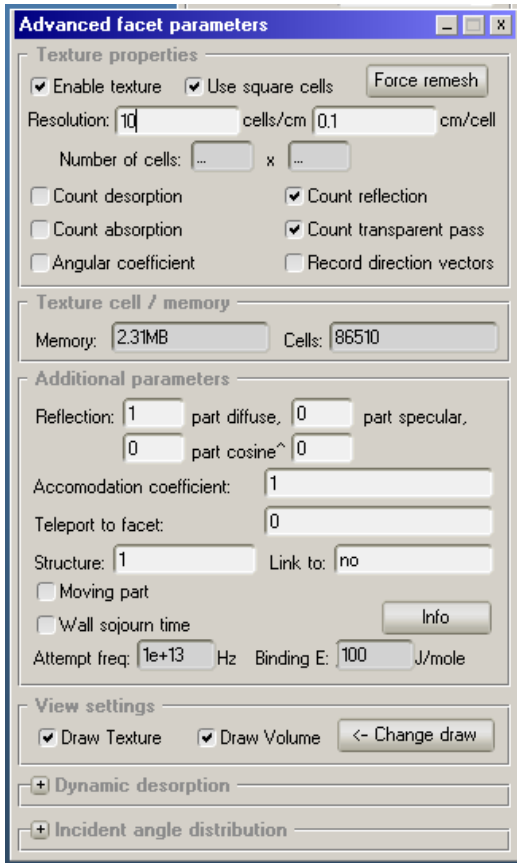

- Click **Enable texture**
- Set the resolution to **10 cells/cm**, a good compromise between details and speed
- Choose **Count reflection** and **Count transparent pass** as options. The former will count pressure on the walls, the latter on the transparent facet we've added for the profile
- Run the simulation. If you turn on the **Texture** option in the upper right corner, you should see the pressure distribution over the geometry:

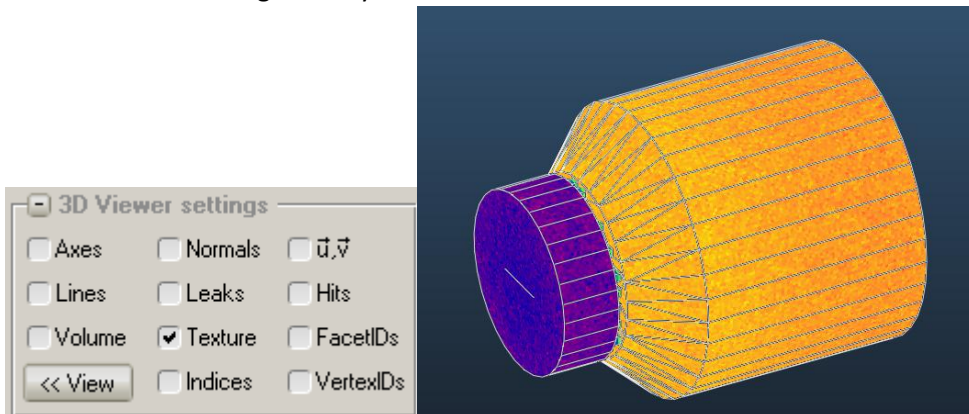



- In the advanced viewer options (click the <<View button), you can choose to render only the front side of facets, which will allow to peek inside the geometry:

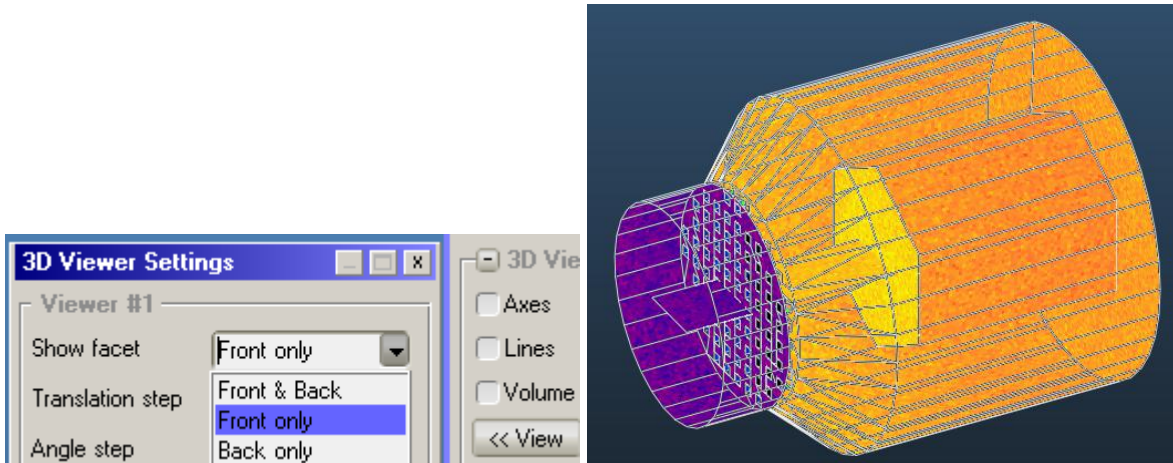

- Finally, to interpret the colors, open the **Texture Scaling** window (CTRL+D):

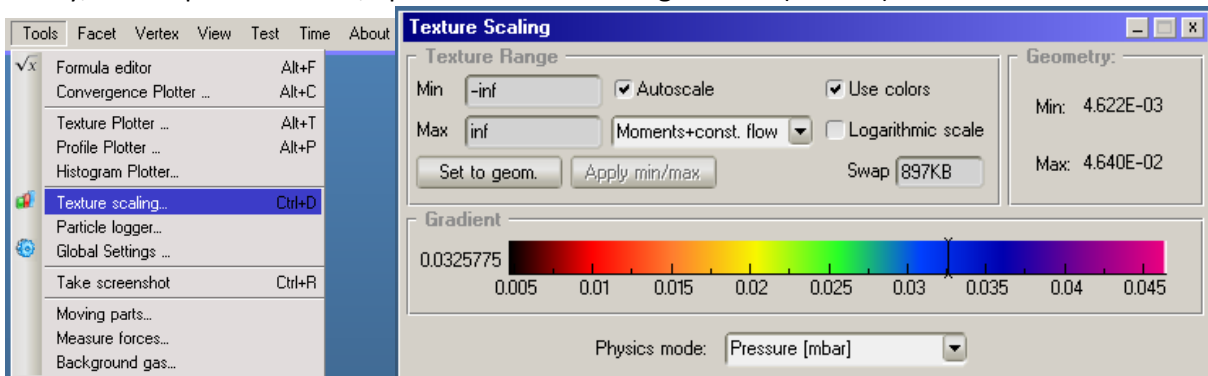

Here, among others, you can switch on logarithmic view, which is more suitable for plotting large pressure differences.

- Finally, you can extract pressure values from a texture by **selecting a textured facet** and opening the **Texture Plotter** window:

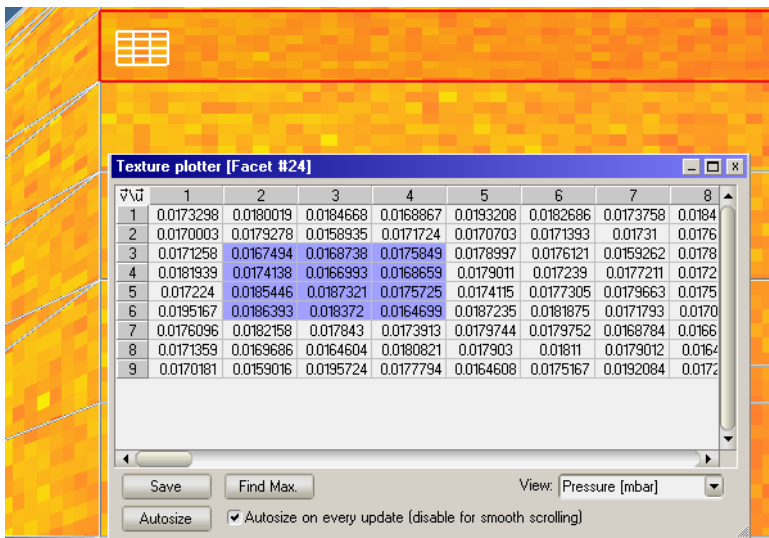

- As seen above, clicking on a cell (or a range of cells) highlights the position on the texture.

It's a good idea to save the simulation now.

You can find the solution in the file **cartridge\_pump\_solved.zip**

## 4) Individual work: Accelerator part simulation

The goal here is to use what you've learned in the previous part and apply it to a fictional beampipe with a light extraction port:

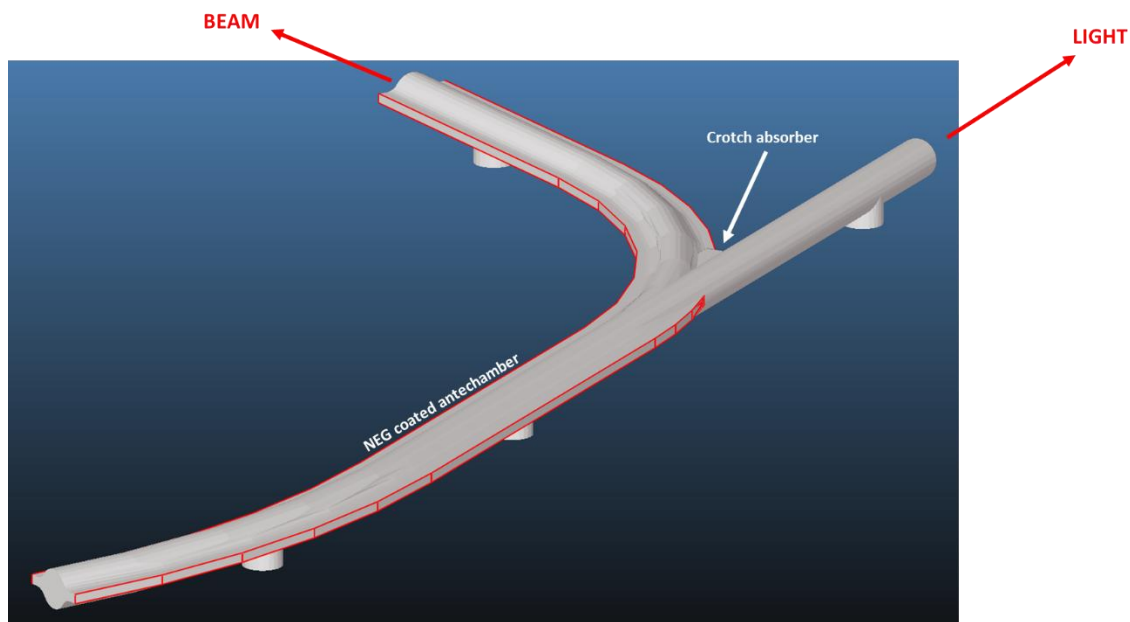

### Gas input

In a real-life scenario, most gas load will come from the crotch absorber part where synchrotron radiation photons hit the wall.

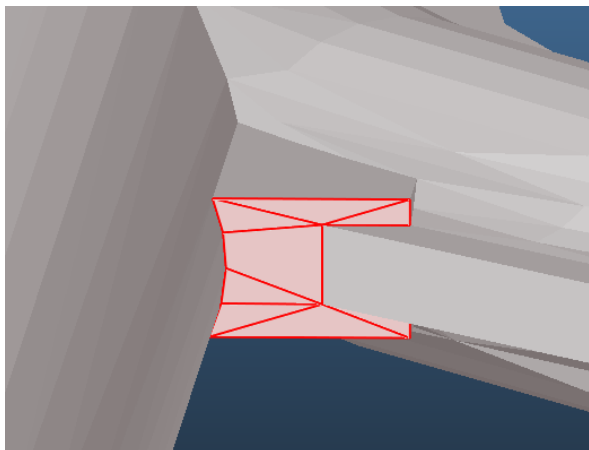

In our model this is represented by 8 facets, and on these facets the gas load is  $0.001 \text{ mbar}\cdot\text{l/s/cm}^2$

### Gas extraction

The system has two types of pumping: four times the NEG cartridge pumps whose speed we've calculated in the previous step (25 l/s each), and the NEG coated antechambers, marked above, with a 5% sticking factor.

The goal here is to set up the outgassing, the pumps, then to calculate the pressure in the mid-plane of the accelerator part on your own.

### Advice

- You can find the geometry in STL format in the file: **extractor.stl** where the units are in cm
- You will see that the Collapse command will leave some facets uncollapsed. This is because CAD programs truncate the coordinates of the composing triangles and thus they don't all lie in the same plane. This is a common problem when importing files, and to solve it you can use the Project command to force all facets to be on the same plane. Use this command with the "defined by 3 selected vertex" option, and select 3 vertices on the circle with the Vertex selector tool (lower right corner, see Molflow cheatsheet). Once the

facets are projected the Collapse command should merge them.

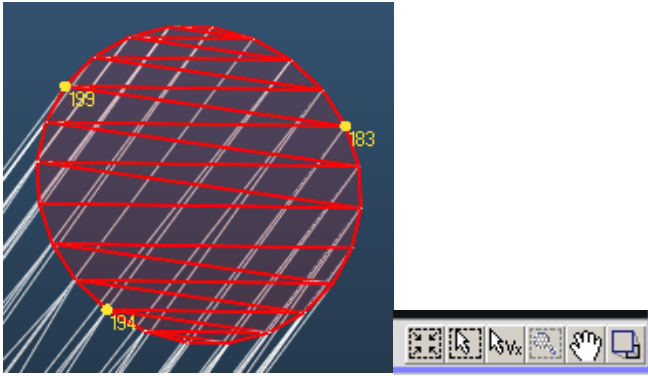

- You don't need to construct the midplane yourself: you can import it from the file **accelerator\_midplane.zip** Use the **File / Insert Geometry / To current structure** command. After inserting, you'll still have to make sure it's transparent, and add a texture on it.
- The NEG antechamber is hard to select. Use the Selection / Smart Select option with 12 degrees as option – this should allow to select the curved antechamber parts with one click.
- Molflow can memorize selections (groups of facets) to recall them later. When you have selected the antechamber parts, for example, you use the Selection / Memorize selection to / New... command to save the selection (or press CTRL+W). Then you can recall these selections by pressing ALT+1, ALT+2, etc.

## 4b) Individual work: a possible solution

### Importing the geometry

- Open the file **extractor.stl** with **centimeters** as units then collapse it:

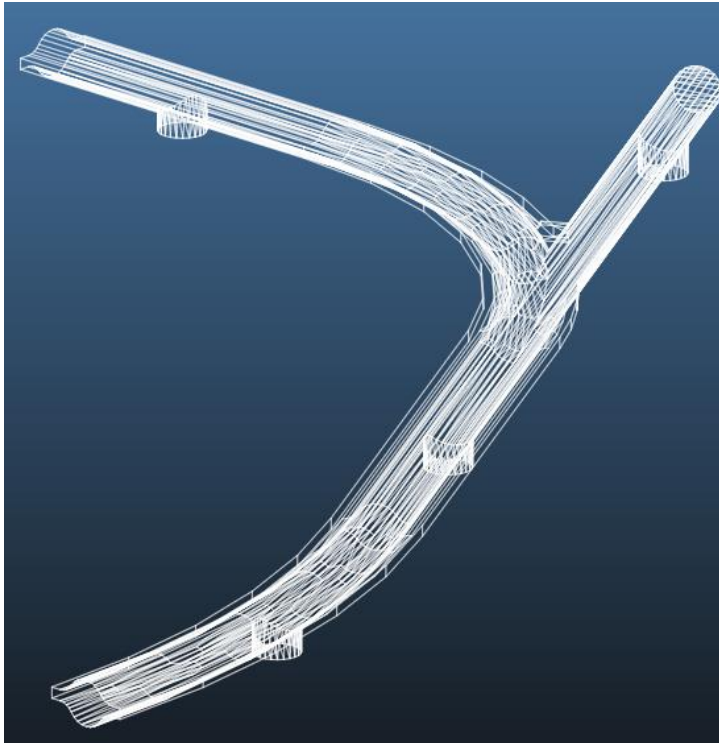

- We'll see that the end of the light extraction didn't collapse. This is a common problem of using STL files, and its cause is that the CAD program exports coordinates with finite precision, and merging these triangles would create a non-planar facet.

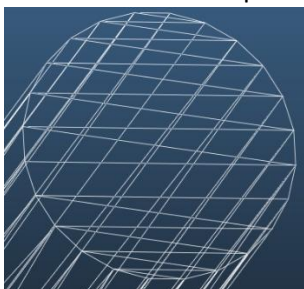

- We can fix the problem by **projecting** all triangles onto the facet's plane. Select the triangles and open the Mirror / Project command:

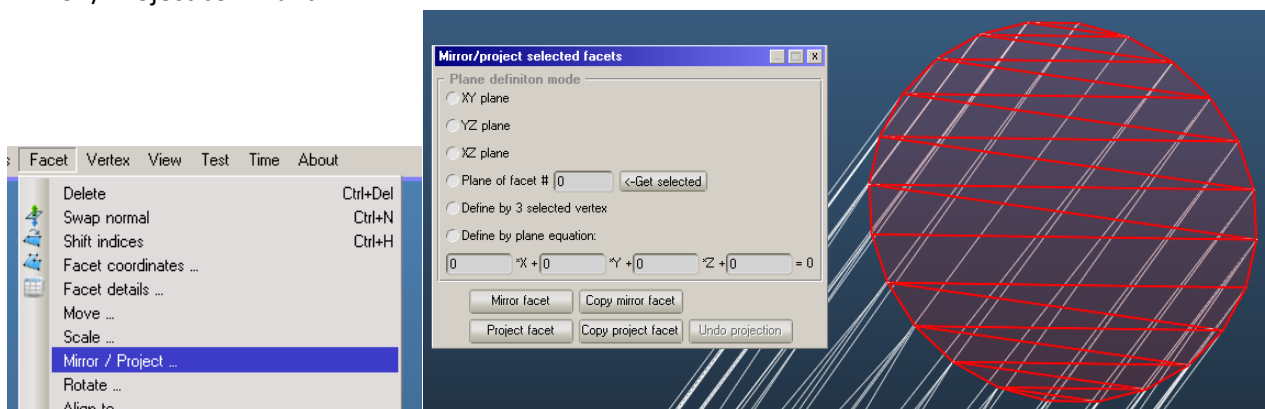

- Choose the **define by 3 selected vertex** option
- Switch to **Vertex selection mode** at the bottom right (cursor with Vx button):



- Select 3 vertices on the end cap (hold SHIFT to add to selection):

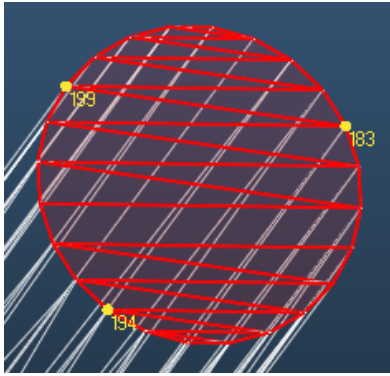

- Click **Project facet** in the mirror / project dialog.
- Visibly nothing happens, however the selected facets have been aligned to the plane. Issue the **Collapse** command again, and the facets will be merged:

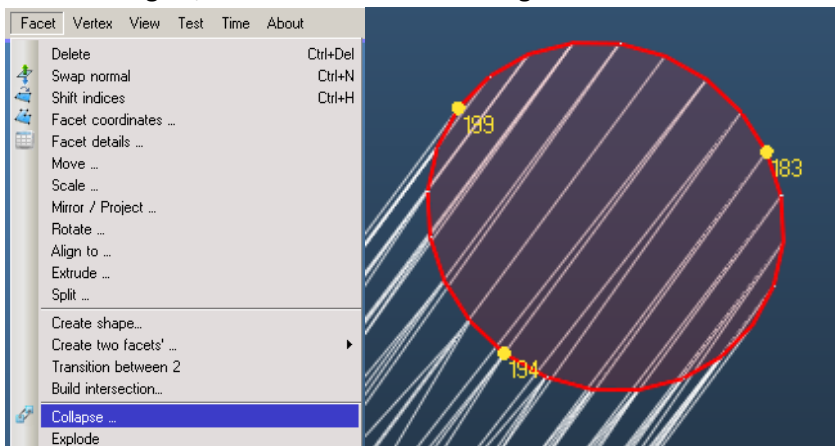

## Setting up pumps

First, we will assign the calculated (effective) pumping speeds to the NEG pumps.

- Select the facets representing them:

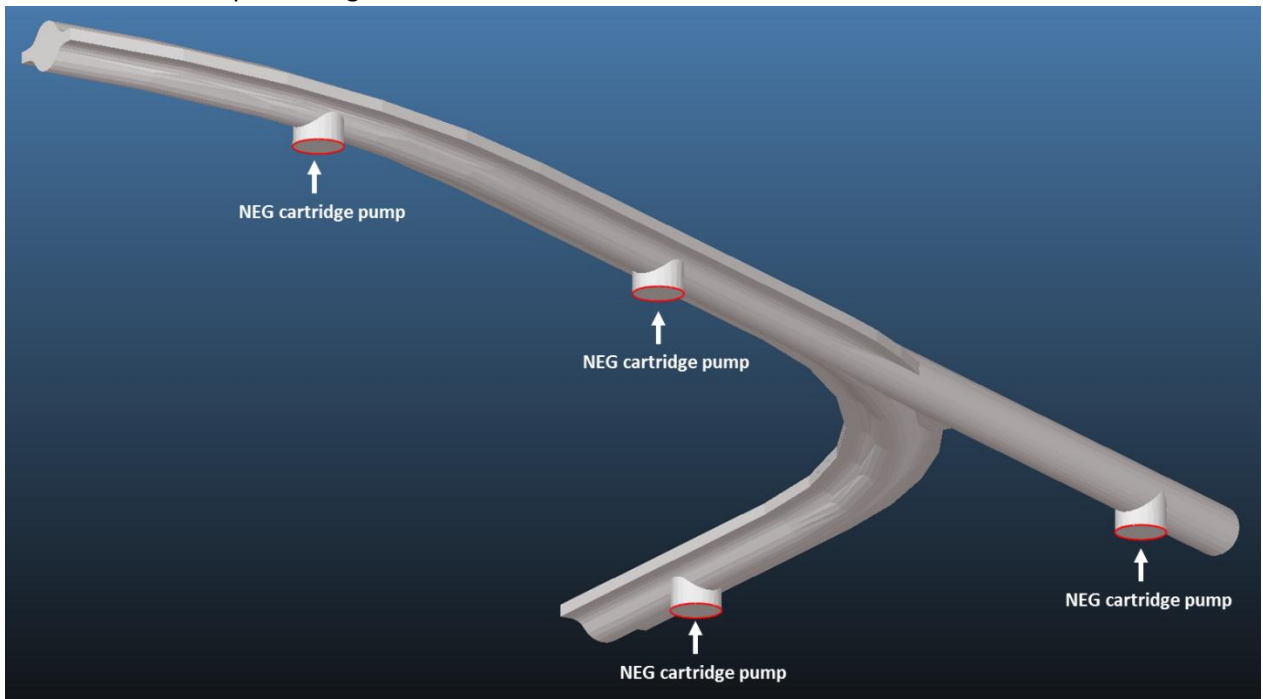

- On the right side, enter the previously calculated 25 l/s pumping speed (if you select the 4 pumps together, you can only edit the sticking factor, enter 0.069 which will correspond to a total of 100 l/s pumping speed):

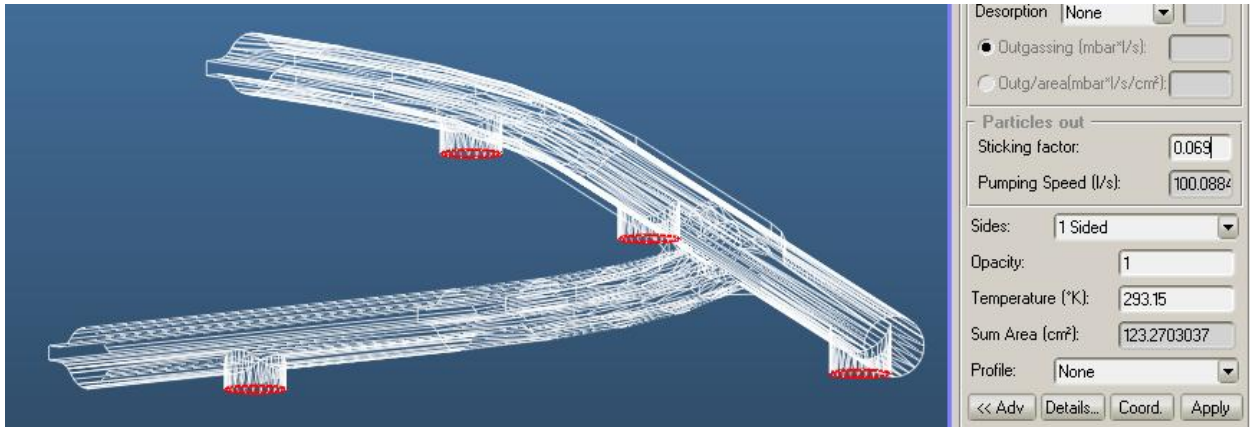

- Next we'll set up the NEG pumps in the antechamber. For this, we'll use the **Smart selection** dialog (first option in the Selection menu):

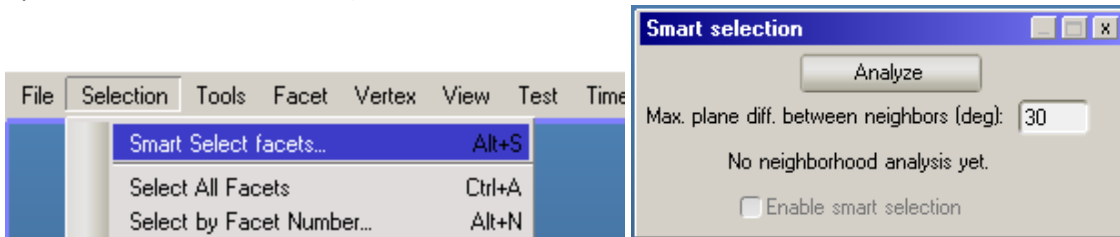

- The first time we use this option, we need to click **Analyze**, at which point Molflow builds a map to know which facets are neighbors of which other.
- The **degree threshold** defines the max. planar deviation which is still selected for the next facet. For our case, set it to 11 or 12 degrees (found by trial and error)
- Then we can click on one of the antechamber facets and the rest should be selected automatically (hold SHIFT to add to the selection):

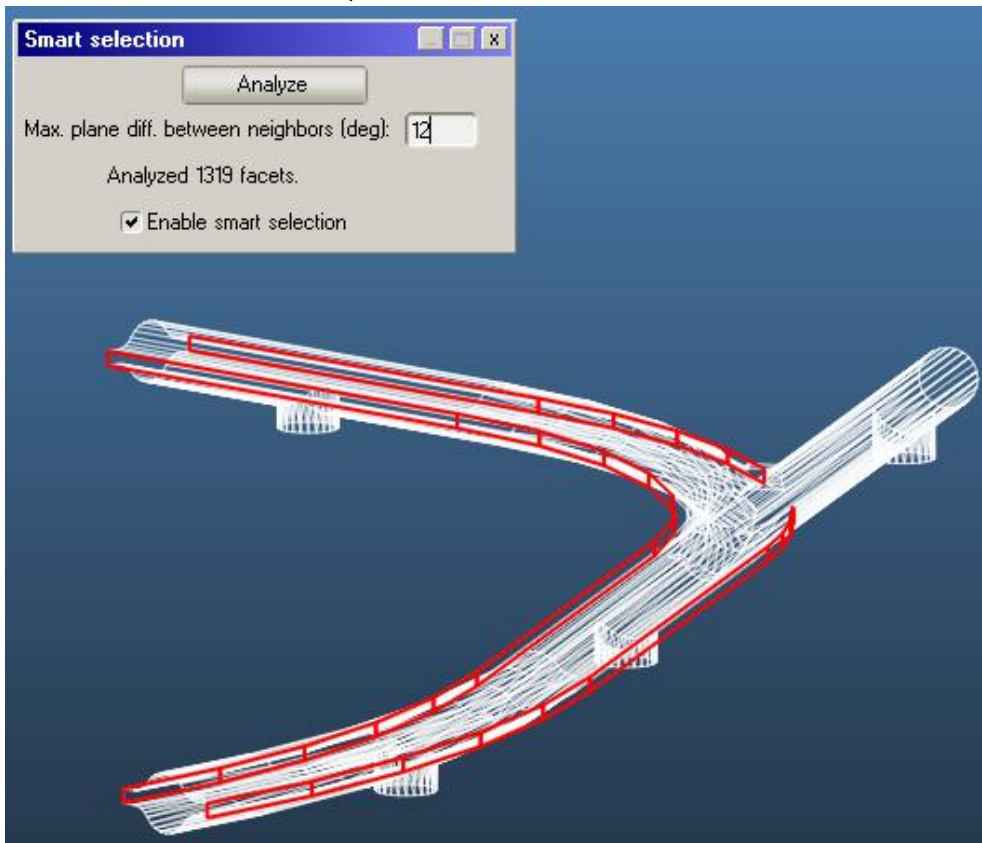

- We can save this selection for later: Choose **Selection / Memorize selection / New...** command (shortcut: **CTRL+W**) and give it a name, for example **Antechamber**:

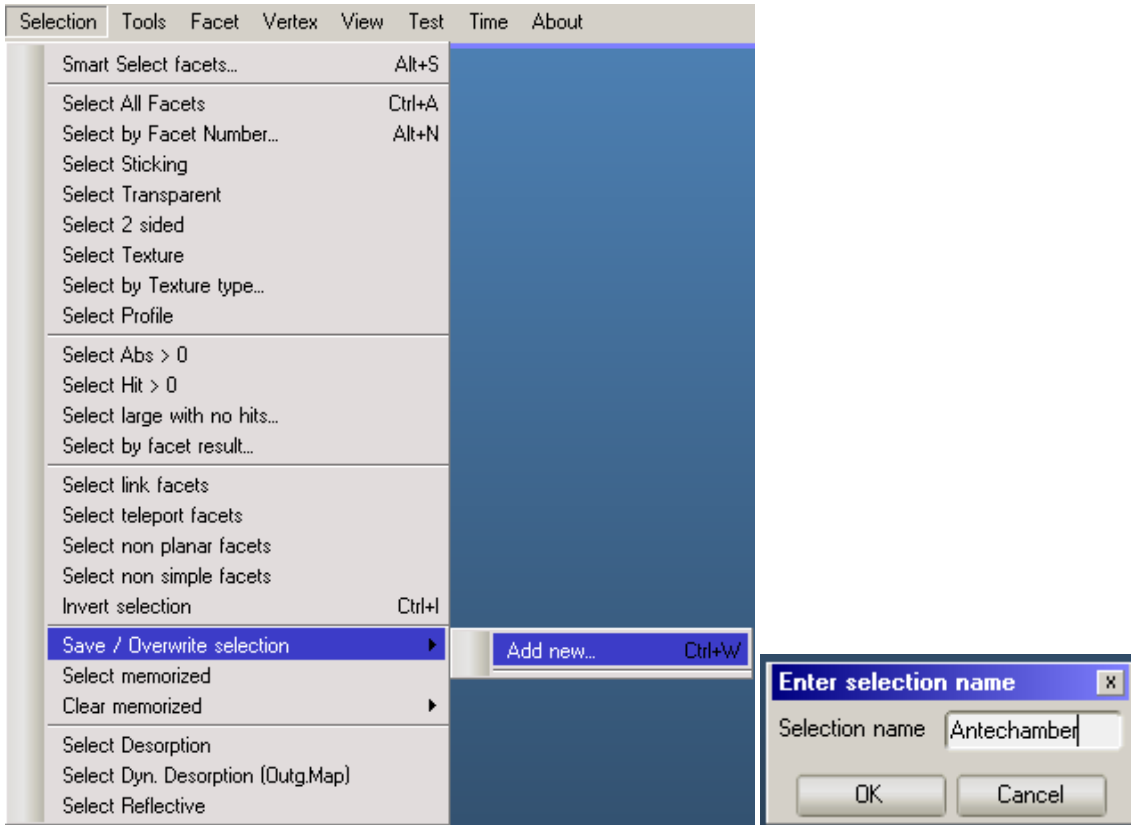

- Now you can recall this selection group anytime by **Selection / Select memorized / Antechamber** (shortcut: **ALT+1** for the first selection group, **ALT+2** for the second, etc.):

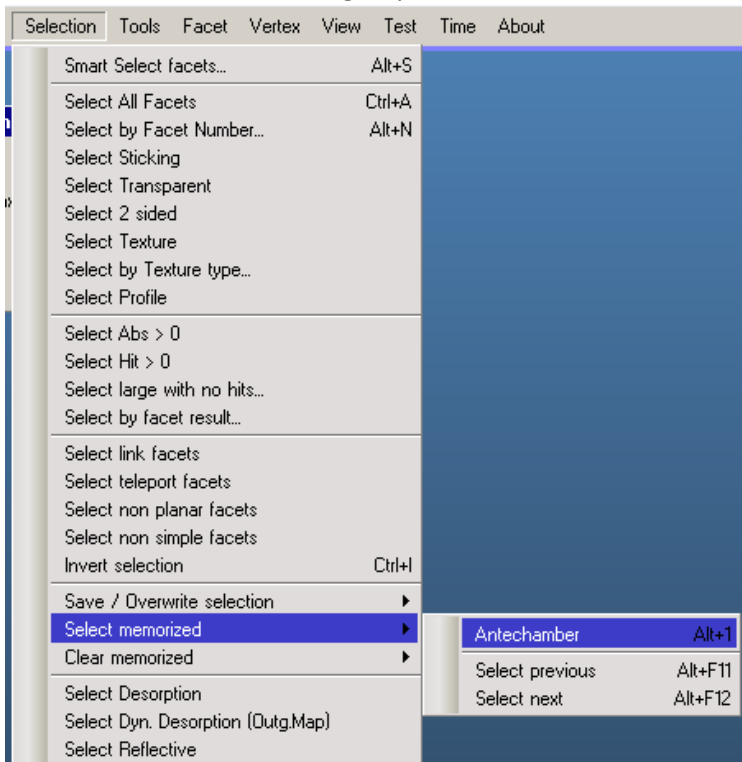

- Finally, set a sticking factor of 0.05 for these facets:

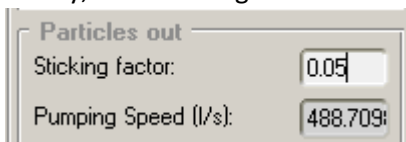

## Setting up the desorption

For simplicity, this model will have only one gas source: the crotch absorber.

- For this, select the perpendicular part of the crotch absorber:

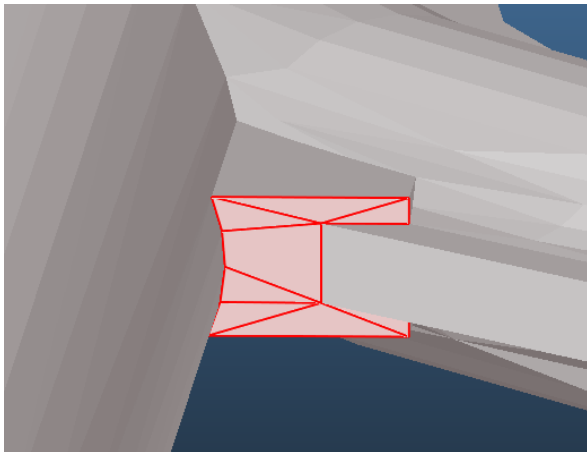

- And set an area-dependent outgassing of  $1E-3$  mbar.l/s/cm<sup>2</sup> :

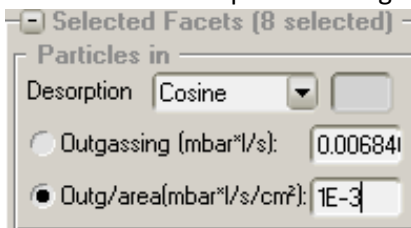

## Adding texture

You can import the half-plane of the accelerator from an external file:

- Choose **File / Insert Geometry / To current structure** and insert **accelerator\_midplane.zip**
- Set it to **2-sided** and set its **opacity to 0**

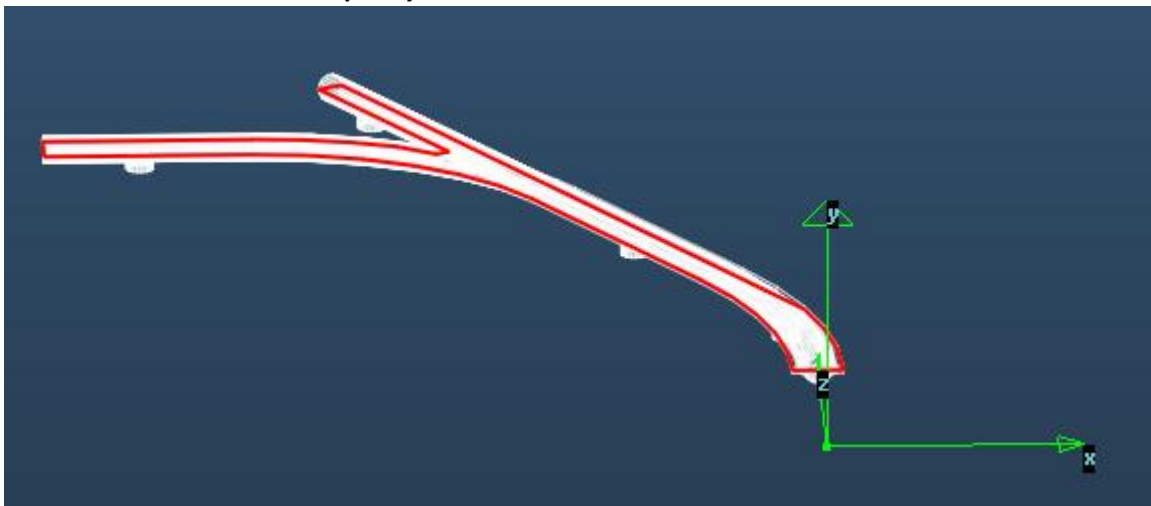

- Add a **texture** with **Count transparent pass** option. Recommended resolution: **3 cells/cm**



- Turn on texture display (upper right) and choose **Front only** view option in the advanced view settings:

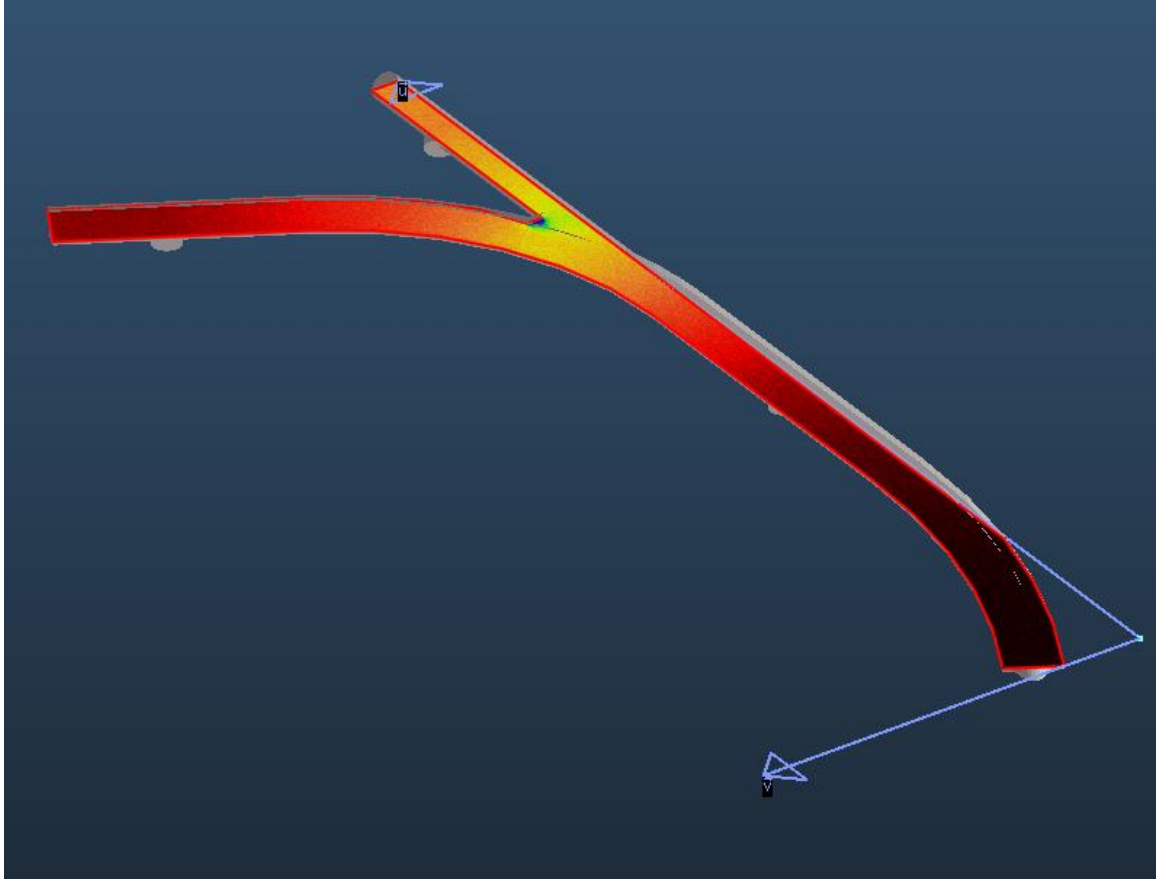

You can adjust the texture scaling in the dialog (opens with **CTRL+D**).

At the end of the job, you should get a texture similar to the above.